

Naturstyrelsen
små huse i skoven

Fugle- udkikstårn uden tag
vers. 2011

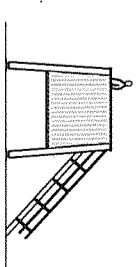

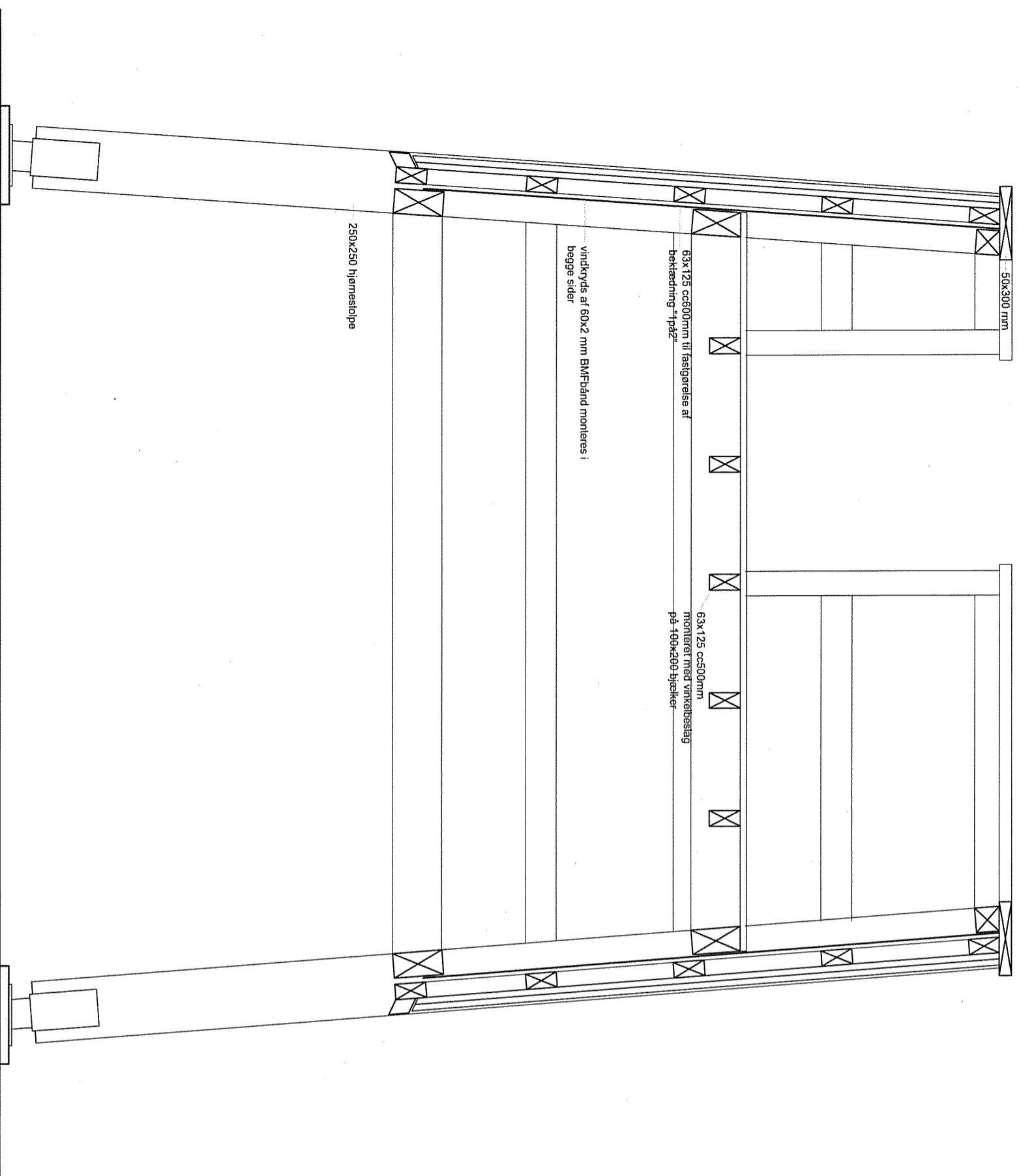

snit A-A 1:20

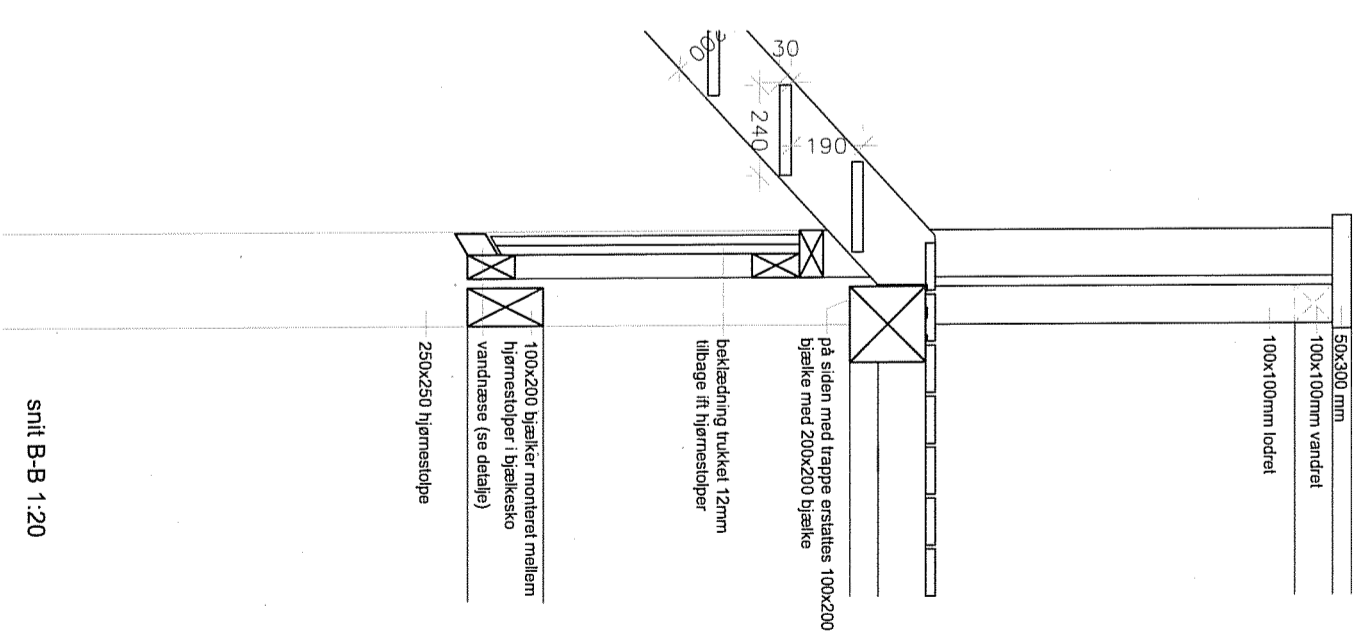

snit B-B 1:20

Naturstyrelsen
 små huse i skoven

Fugletårn uden tag - snit
 mål 1:20 2011

på forsiden monteres vindkryds af fladjern 6x45 mm slidsset ind i søjle og monteret med buldog Ø95 (se detalje). der er behov for kraftigere vindkryds på denne side, da der p.g.a. trappen ikke er vindkryds på tåmets bagside.

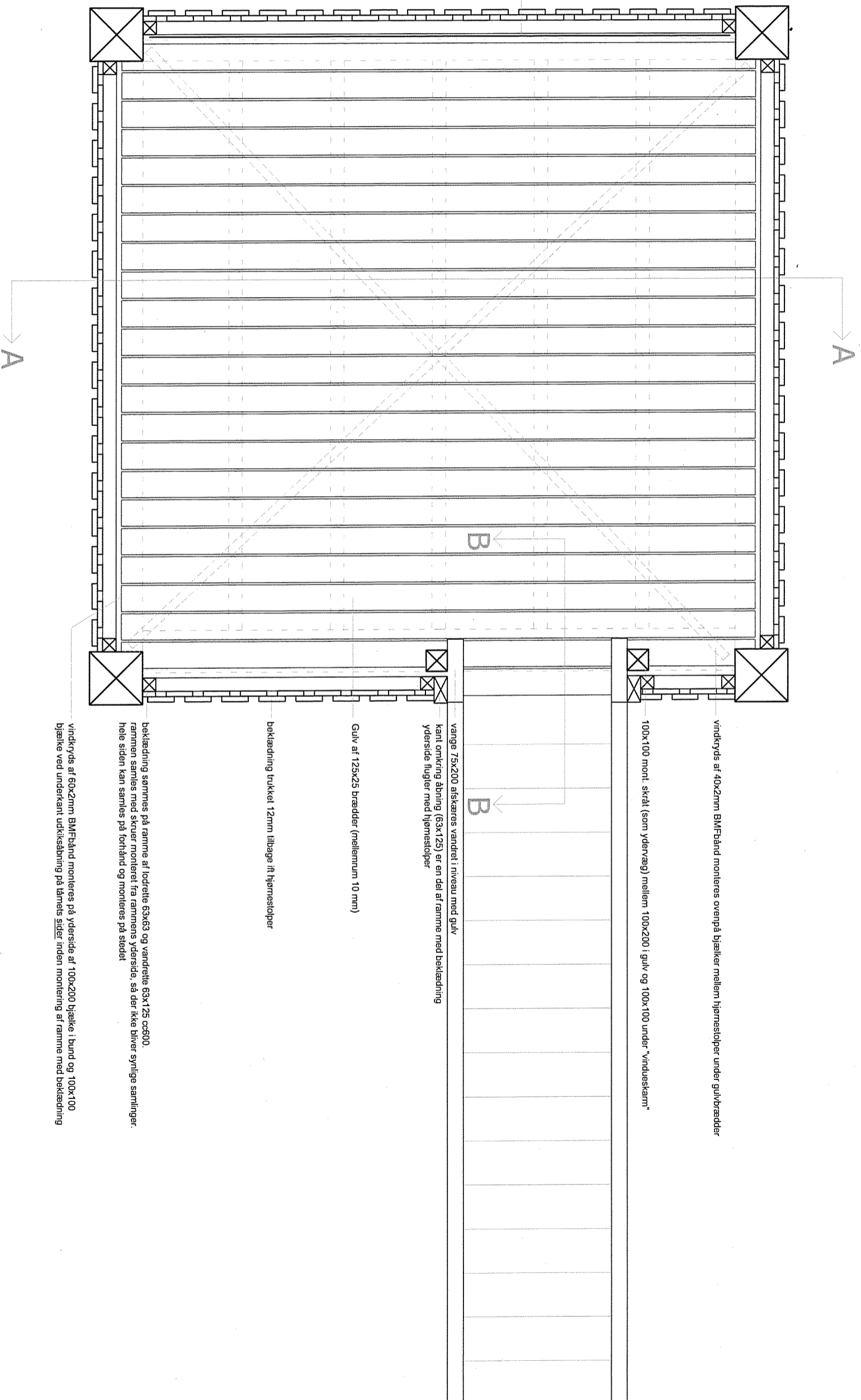

Naturstyrelsen
små huse i skoven

Fugletårn uden tag - plan
mål 1:20 2011

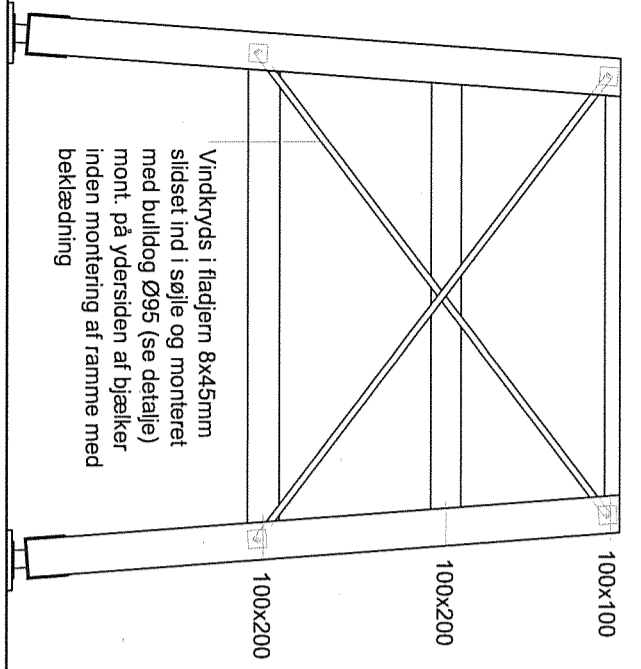

grundkonstruktion front 1:50

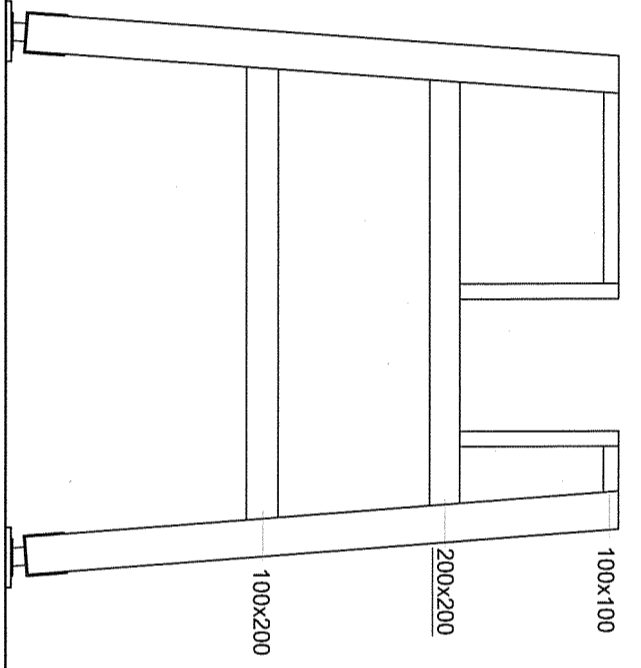

grundkonstruktion bag 1:50

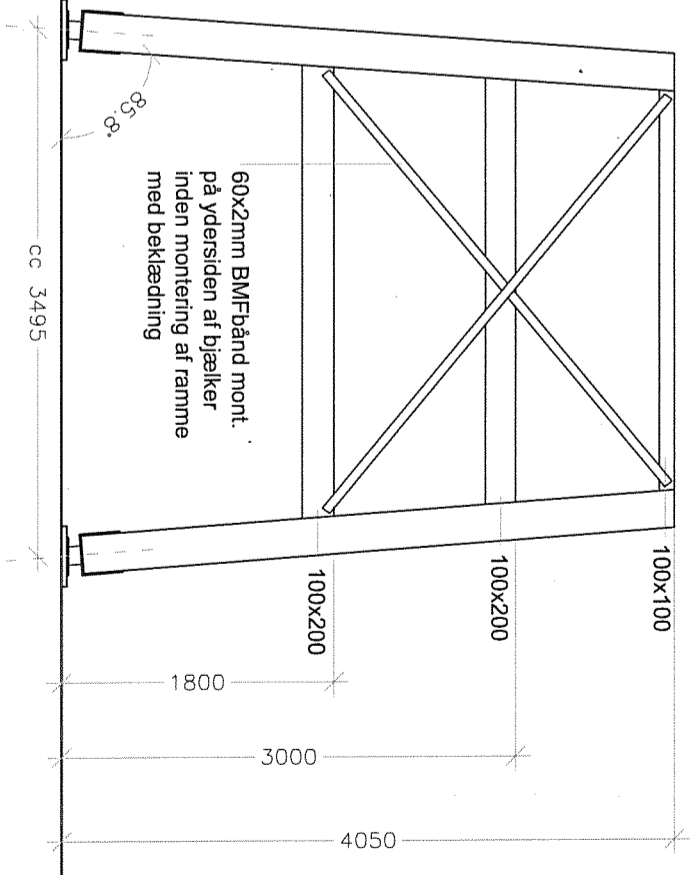

grundkonstruktion sider 1:50

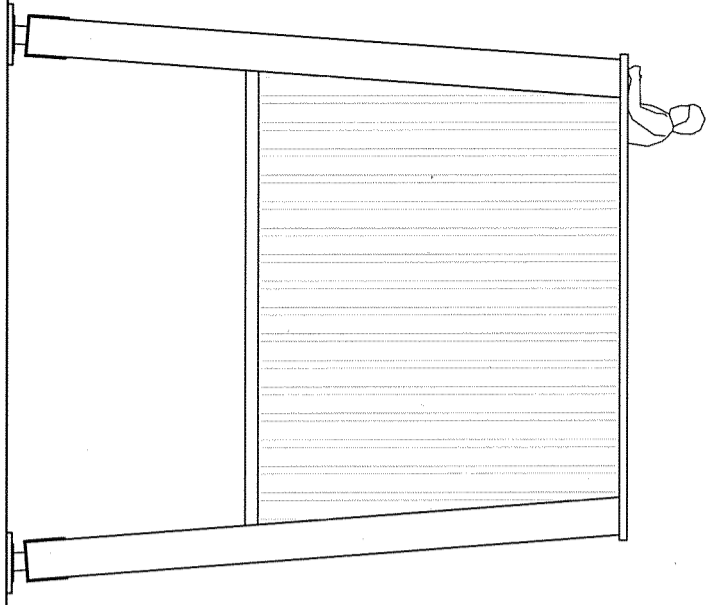

opstalt front 1:50

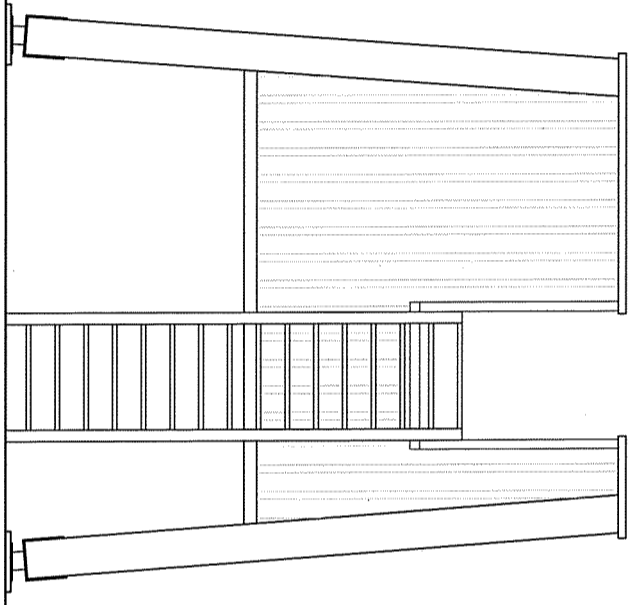

opstalt bag 1:50

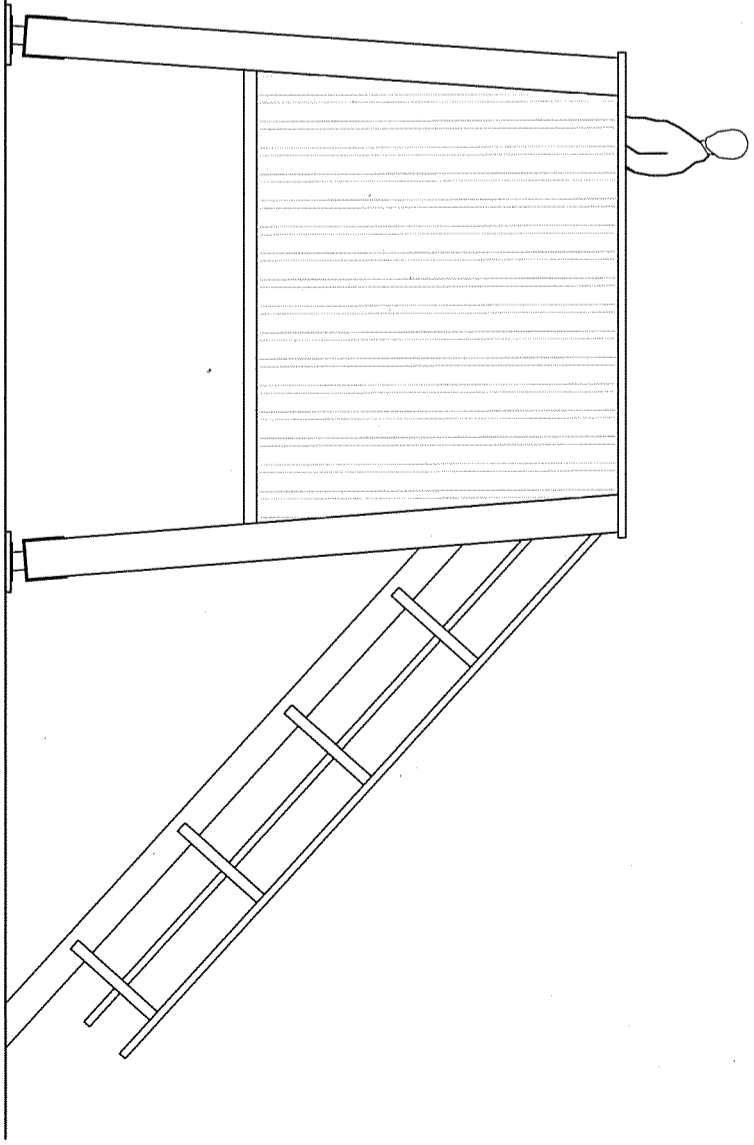

opstalt side 1:50

Naturstyrelsen
små huse i skoven

Fugletårn uden tag - opstalter
mål 1:50 2011

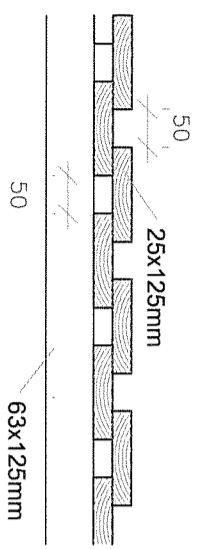

lodret beklædning "1 på 2" 1:10

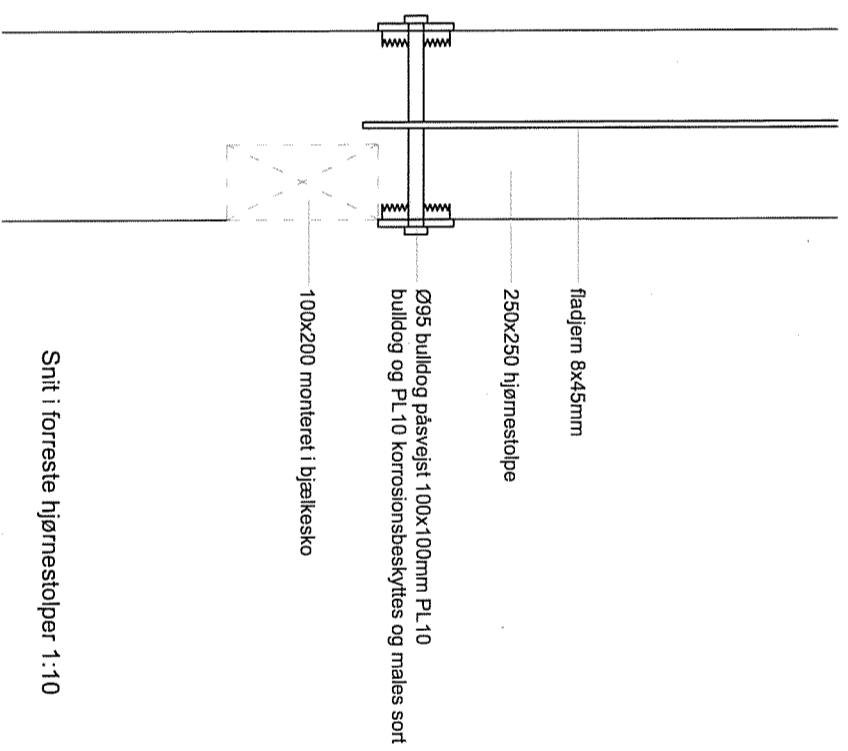

Snit i forreste hjørnestejler 1:10

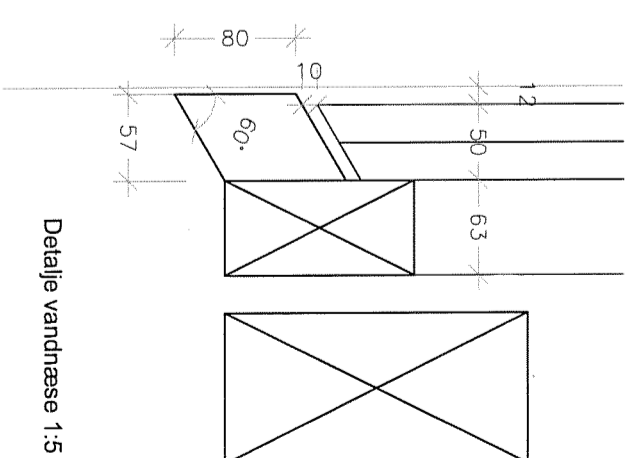

Detail vandbræse 1:5

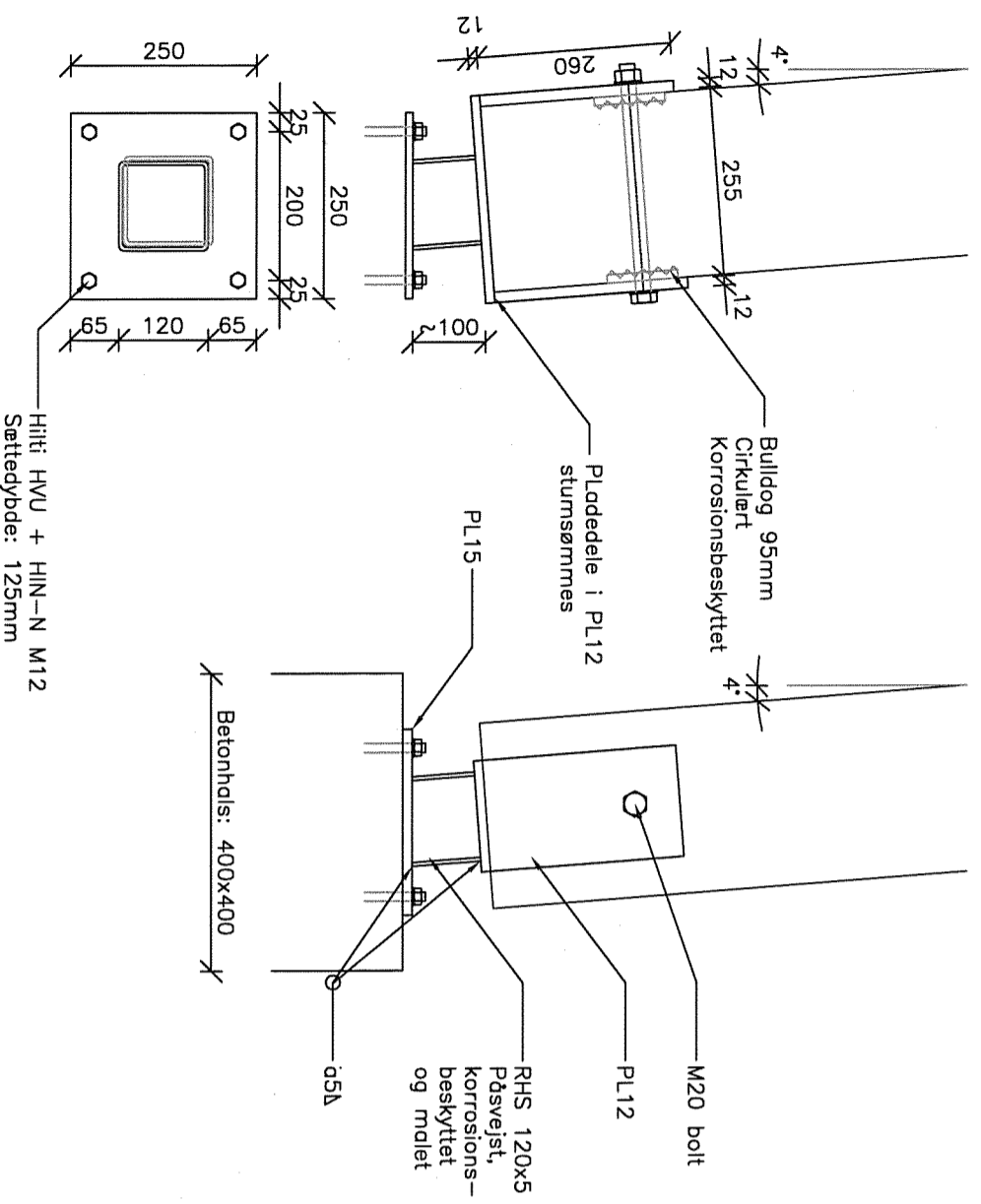

Stålele:
Alle pladedele i S355
Korrosionsbeskyttes til korrosionskategori C3

Hilti HVU + HIN-N M12
Sætedybde: 125mm

Fodbeslag 1:10

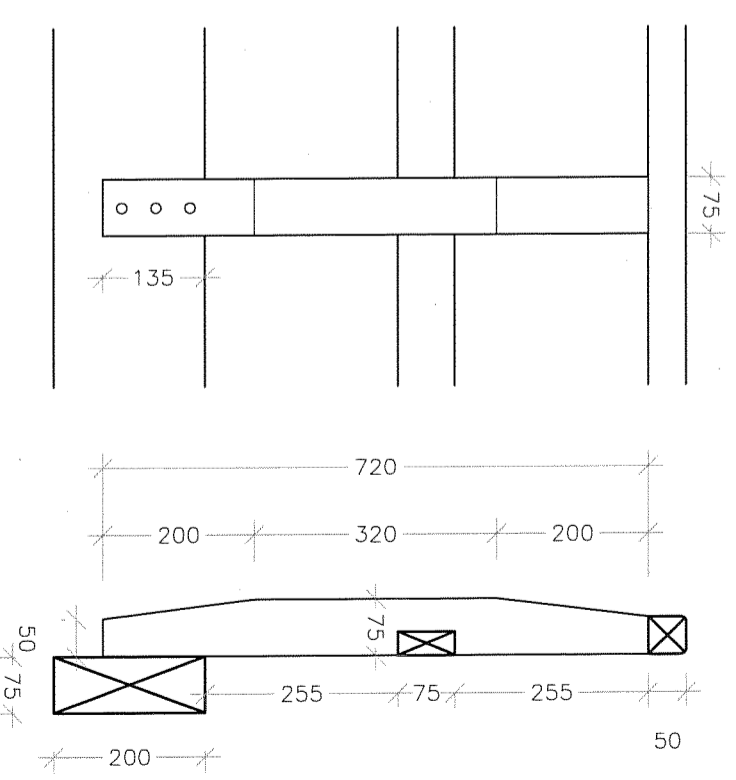

Opstalt og snit i vange og balustre 1:10